

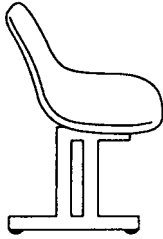







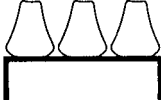

### GENERAL INFORMATION

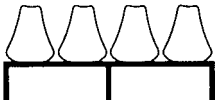

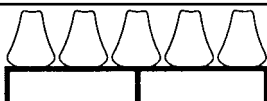
MODEL "CMD"

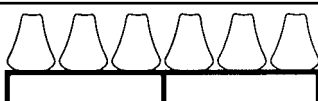
The fiberglass seats are durable, institutional quality and are exceptionally comfortable. The table tops are surfaced with wear resistant high pressure plastic laminates. The seats and table tops are available in a wide variety of our standard colors and can be mixed or matched. Special fiberglass table tops are available in the deluxe finishes for color coordinating. All units are self leveling and have heavy rust resistant steel angle frames with 1 1/2" sq. tubular steel legs. Component parts are individually replaceable for economical maintenance. Black is the standard color for all metal parts. The legs have non-marking plastic feet, and are equipped for concealed bolt down. We highly recommend securing furnishings in place where abusive use is possible.

SEATING UNITS WITHOUT TABLES		SEATING UNITS WITH TABLES		PRICES
	Model CMD-2 Length 40" Weight 38 lbs.		Model CMD-2T Length 41" Weight 41 lbs.	\$259.00
	Model CMD-3 Length 61" Weight 52 lbs.		Model CMD-3T Length 61" Weight 55 lbs.	\$360.00
	Model CMD-4 Length 82" Weight 66 lbs.		Model CMD-4T Length 82" Weight 69 lbs.	\$474.00
	Model CMD-5 Length 103" Weight 84 lbs.		Model CMD-5T Length 103" Weight 87 lbs.	\$576.00
	Model CMD-6 Length 124" Weight 94 lbs.		Model CMD-6TT Length 124" Weight 99 lbs.	\$653.00

### ACCESSORY TABLES

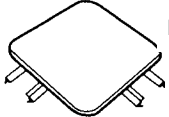
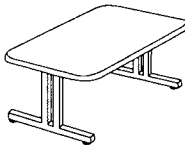
Model TM-1	REPLACEMENT TABLE TOP - Laminated plastic 18" x 21" is interchangeable with seats and can be placed in any position on the unit. Available in your choice of our standard colors (included on the above units with tables - see CMD-6TT for example). Weight is 11 lbs.  A fiberglass TM-1 top is available in the Deluxe finishes for color coordinating (call for pricing).		Price \$70.00
Model TM-2	CORNER TABLE MODULE. Fastens any two of above seating units together to form a single 90 unit for corner use. Modification of seating unit legs is required, so order as a set. Laminated 24" x 24" top. Steel frame and leg. Choice of standard colors. Weight 27 lbs.  A fiberglass TM-2 top is available in the Deluxe finishes for color coordinating (call for pricing).		Price \$188.00
Model TM-3	MAGAZINE/COFFEE TABLE compliments the modular seating units whether used in line or out in front. Laminated plastic table top, steel frame and legs with adjustable levelers and non-marking plastic feet. 18"W x 36"L x 15"H. Choice of standard colors. Weight 39 lbs.  A fiberglass TM-3 top is available in the Deluxe finishes for color coordinating (call for pricing).		Price \$234.00

### F-200 REPLACEMENT SEAT



The F-200 fiberglass replacement seats are institutional quality and exceptionally comfortable. They are available in all of our standard colors and will fit any Solomatic® seating frame produced since 1970. Weight 6 lbs.

Model F200 replacement seat without legs Price \$70.00 each

### INDIVIDUAL STOOLS

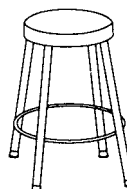

Individual stools with the same attractive wear resistant fiberglass seats used on our Seat-Table Units. The seat is a generous 13" in diameter and its 26" height is perfect for the comfortable seated use of folding tables and similar work stations by employees and customers. Sturdy welded steel frame with foot rest and non-marking glides. A bolt down version is available. Weight 19 lbs.

Model SS-1 Price \$144.00 each

# Sol-O-matic®

## "The Go Anywhere Units" LIST PRICE SCHEDULE EFFECTIVE 11-01-2008 INDOOR & OUTDOOR SEAT-TABLE UNITS

Weather & wear resistant fiberglass seat-table units for pools, patios, snack bars, lunch rooms, customer and employee lounge areas, etc. The sturdy single-unit design eliminates loose chair problems and provides safe, easy to clean accommodations indoors or out. The attractive slate textured table tops and the seats are molded in one piece from polyester fiberglass. The welded steel frames are made from heavy gauge tubing treated to resist rust and their standard color is black. Seats and table colors may be ordered mixed or matched in standard & deluxe colors. The legs have adjustable levelers and non-marking plastic feet. Non-bolt down is standard but bolt down styles can be supplied at no extra cost. We highly recommend securing furnishings in place if abusive use is possible.

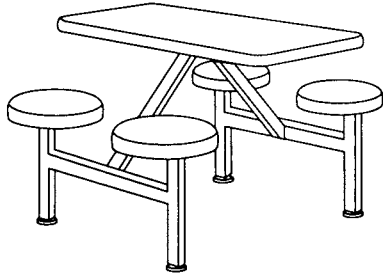

MODEL STF-2444 Price \$783.00  
4 Fiberglass Seats & 24" x 44" Table.  
Overall size 44" x 53", Weight 93 lbs.

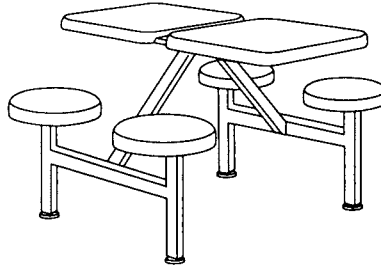

MODEL STF-2444D Price \$810.00  
4 Fiberglass Seats & two 20" x 24"  
Tops. Overall size 44" x 53", Wt. 96  
lbs.

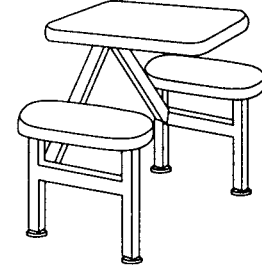

MODEL STF-2224 Price \$561.00  
2 Fiberglass Seats & 22" x 24" Table.  
Overall size 22" x 50", Weight 72 lbs.

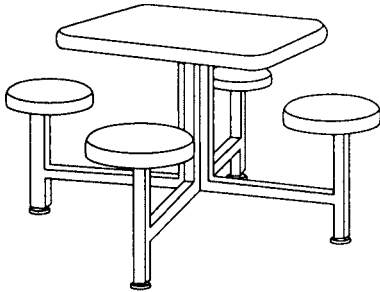

MODEL STF-3030 Price \$754.00  
4 Fiberglass Seats & 30" x 30" Table.  
Overall size 46" x 46", Weight 93 lbs.  
Note: For use with umbrellas  
order as Model STF-3030U.

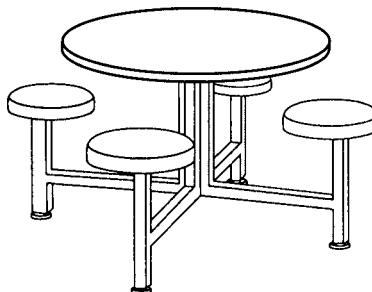

MODEL STF-3600 Price \$783.00  
4 Fiberglass Seats & 36" dia. Table.  
Overall size 50" x 50", Weight 93 lbs.  
Note: For use with umbrellas  
order as Model STF-3600U.

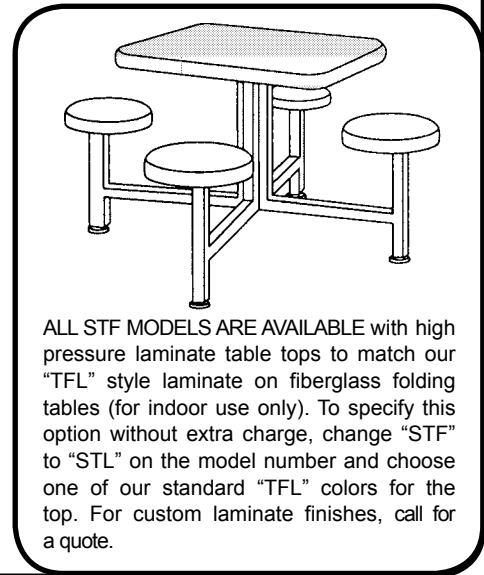

ALL STF MODELS ARE AVAILABLE with high pressure laminate table tops to match our "TFL" style laminate on fiberglass folding tables (for indoor use only). To specify this option without extra charge, change "STF" to "STL" on the model number and choose one of our standard "TFL" colors for the top. For custom laminate finishes, call for a quote.

## FIBERGLASS INDOOR & OUTDOOR BENCHES

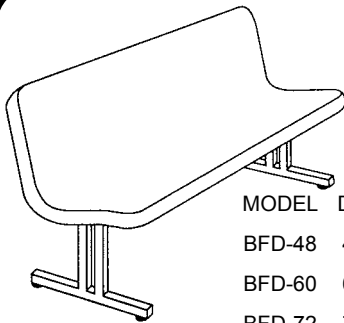

### CONTOURED BENCH

MODEL	DESCRIPTION	WEIGHT	PRICE
BFD-48	48" Fiberglass	62 lbs.	\$623.00
BFD-60	60" Fiberglass	70 lbs.	\$671.00
BFD-72	72" Fiberglass	79 lbs.	\$721.00

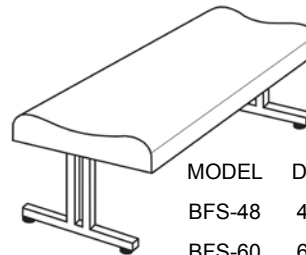

### CONTOURED BACKLESS BENCH

MODEL	DESCRIPTION	WEIGHT	PRICE
BFS-48	48" Fiberglass	54 lbs.	\$391.00
BFS-60	60" Fiberglass	62 lbs.	\$425.00
BFS-72	72" Fiberglass	70 lbs.	\$457.00

The comfortable contoured benches are molded in one piece from weather and wear resistant polyester fiberglass. They can provide attractive space efficient seating accommodations indoors or out. The backless benches offer comfortable seating from either side and are ideal for island use. The heavy steel leg assembly is treated to resist rust and has adjustable levelers with non-marking plastic feet. The seats are available in all our standard & deluxe colors. The backs of the upright seats have a satin textured finish matching the front color. The standard leg color is black. Concealed bolt down provisions are standard. We highly recommend securing furnishings in place if abusive use is possible.

# Sol-O-matic®

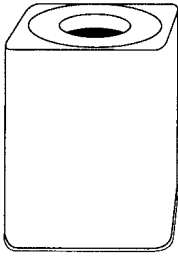

## TRASH CAN COVERS

Sol-O-matic's® Fiberglass Trash Can Covers provide a colorful and tasteful solution to an often unsightly problem. The covers are designed to fit over most standard plastic or metal trash containers up to 35 gallon capacity. They are rugged yet light enough to be easily lifted when emptying the container. They are available in a wide selection of attractive colors and can be used indoors or out. Cover weighs approx. 24 lbs. Shipping weight is 34 lbs. 24" x 24" x 30"H.

Model RCC-32 Price \$352.00

## ORDERING INFORMATION

All Sol-O-matic's® products are custom manufactured to order. The component parts are stock, but the final assembly/packaging is to order only. The normal shipping time required after the receipt of an order is approximately 30 days for all products.

We do not maintain warehouse facilities for finished products and for this reason, all orders must be completely cleared for shipment before they are released for assembly (i.e. prepayment received or credit approved, etc.)

Orders that are clear to ship are scheduled for assembly with priority given to the order with the earliest receipt date. Orders placed on a "Check with Order" basis will gain seniority while waiting for the check, but they cannot be scheduled for final assembly until the check is received.

All our products are packaged for shipment via common carrier. We have agreements with several major motor freight lines that enable us to provide a 60% to 67% freight discount on most interstate shipments. We will honor requests for specific carriers, but we may not be able to protect the discount. All shipments must be freight collect unless credit has been established in advance. A 10% handling charge will be levied on all prepaid freight charges.

The carrier is responsible for all damage in transit. Inspect your shipments closely and make notations of any visible abuse on the waybill before signing it. Carriers will attempt to deny or reduce payments made on claims that do not have the proper notation on the delivering waybill. Inspect all shipments for concealed damage within seven days. The carrier must be notified within 10 days of delivery on any damage claim, concealed or otherwise. Failure to follow the above procedures can forfeit any rights of recovery.

No orders for C.O.D. shipments can be accepted due to the custom nature of the finished products.

Prices and specifications subject to change without notice.  
All items shipped knocked down, F.O.B. Houston, Texas.

### Standard Fiberglass Colors

(available on all fiberglass  
and Laminate products)

Almond  
Peaceful  
Burgundy  
Cornflower  
Surfin'  
Holly Red  
Hunter Green  
Purple  
Marigold  
Raspberry  
Smoke  
Platinum  
Regal Blue  
Orange  
White

Custom Colors Quoted  
Upon Request.

### Deluxe Fiberglass Colors

(available on most products for an upcharge)

Almond Granite  
Black Granite  
Coral Sea  
Brownstone  
Burgundy Dust  
Waterfall  
Guacamole  
Ocean Wave  
Peacock Dust  
Peppermint  
Purple Fire  
Firecracker  
Rainforest  
Starlight  
Sunrise  
White Granite

Call for a quote based  
on your specific order.

MANUFACTURED BY:

**CACO MANUFACTURING CORP.**  
P.O. Box 263129 Houston, Texas 77207  
PHONE (800) 633-6718 www.solomatic.com

DISTRIBUTED BY:

# Sol-O-matic®

## FIBERGLASS "The Original" FOLDING TABLES

"Often Copied but Never Equaled" DESIGNED FOR COIN LAUNDRY SERVICE

### GENERAL INFORMATION

These tables are available in all our standard & deluxe colors. They have seamless one-piece molded fiberglass tops that are mirror smooth, easy to clean and impervious to most spotting fluids. The work surfaces are at the preferred 34" height and have 3" high stop ledges at the ends and back to greatly increase the usable area. Ample clearance is provided under the top for laundry cart storage. The standard color for all metal parts is black. All tables have adjustable levelers with non-marking plastic feet and can be bolted to the floor. We highly recommend securing furnishings in place if abusive use is possible.

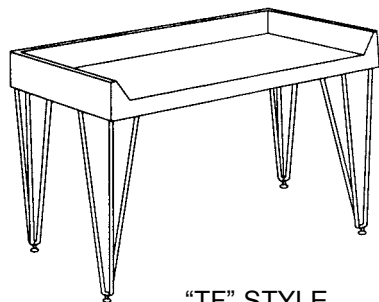

"TF" STYLE

MODEL	SIZE	WEIGHT	PRICE
TF-244	24" x 48"	64 lbs.	\$424.00
TF-245	24" x 60"	70 lbs.	\$463.00
TF-246	24" x 72"	75 lbs.	\$503.00
TF-304	30" x 48"	67 lbs.	\$432.00
TF-305	30" x 60"	77 lbs.	\$472.00
TF-306	30" x 72"	87 lbs.	\$509.00

All "TF" style tables have four heavy steel tripod legs and a work surface height of 34". They can be equipped with upper shelves and clothes racks, but are not adaptable to the built-in trash containers or the full-length hanging racks.

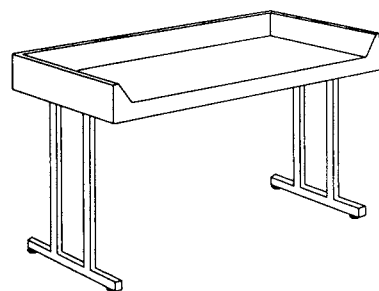

"TFD" STYLE

MODEL	SIZE	WEIGHT	PRICE
TFD-244	24" x 48"	73 lbs.	\$503.00
TFD-245	24" x 60"	81 lbs.	\$543.00
TFD-246	24" x 72"	89 lbs.	\$582.00
TFD-304	30" x 48"	76 lbs.	\$509.00
TFD-305	30" x 60"	84 lbs.	\$550.00
TFD-306	30" x 72"	101 lbs.	\$589.00

All "TFD" style tables have sturdy 1 1/2" sq. tubular steel leg units secured directly to steel cross frames bracing the table top. The legs can be provided with matching color panels and are equipped for concealed bolt down. Standard height is 34" but other heights are available.

Add for color leg panels \$89.00

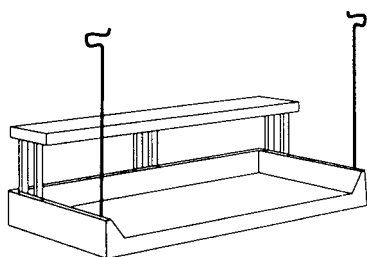

#### UPPER SHELVES

Any table can be ordered with a matching upper shelf installed to enhance its work space. To specify the shelf, simply add a "U" to the end of the table's model number. The shelves are 12" deep, 16" high and have tubular steel supports. Approximate weight is 22 lbs.

Add for shelf:  
4'=\$202.00 5'=\$218.00  
6'=\$235.00

#### CLOTHES RACKS

Theft and vandal resistant solid steel clothes racks are available on one or both front corners. When single racks are ordered they will be placed on the left side (facing table) unless otherwise specified. Due to the special drilling required, the racks must be factory installed. Weight 3 1/2 lbs.

Model TR-2F  
Price \$28.00 each installed

#### FULL-LENGTH HANGING RACK

Can fit on any new or existing table with the TFD style legs. Provides ample space on each end for long garments while allowing complete use of the over table area for shorter garments. Made of tubular steel and bolts securely to the tables legs. Bolt down is required. Weight is approx. 19 lbs. Item not shown.

Models TR-4', TR-5', TR-6'  
Price \$130.00 each

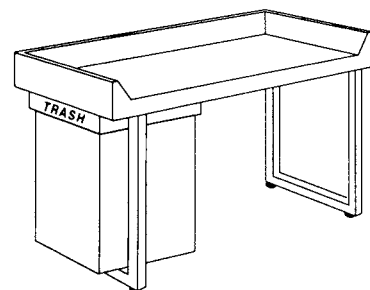

#### BUILT-IN TRASH CONTAINERS

Space saving fiberglass trash containers can be factory installed under all "TFD" style folding tables. The containers tilt out at the top for convenient use and then self close to hide the clutter. They are designed to use standard 32-gallon trash bags and lift out for easy emptying. They are available in all standard table colors and can be used on one or both ends of the table. Weight 34 lbs.

Model TRC-32 Price \$327.00 each installed